



A leading producer of monolithic refractories and precast refractory shapes for the foundry, steel, aluminum, copper and zinc metals markets as well as the cement, power, incineration, mineral processing and boiler industries.

Global **Refractory** Solutions



WHAT WE DO

In 1961 Allied Mineral Products began producing monolithic refractories for the foundry industry. Since then we have become a global force in the design and manufacture of monolithic refractories and precast refractory shapes for a wide range of metallurgical and industrial applications. We pride ourselves on providing leading products, custom engineering services and exceptional field support.

WORLDWIDE SALES & SERVICE FORCE

With Allied, you have a partner committed to *being there worldwide with refractory solutions*. Our technically trained sales and service teams ensure efficient and effective product recommendations and installation support. Additionally, our product services team provides troubleshooting and technical field service to our customers.



13 MANUFACTURING FACILITIES

OVER **145** INTERNATIONAL SALES REPRESENTATIVES

3 RESEARCH AND TECHNOLOGY FACILITIES

SALES ACTIVITY IN MORE THAN **100** COUNTRIES

6 PRECAST SHAPES FACILITIES

INNOVATION

We're a technology frontrunner in patented new product design and continuously work to improve our core product lines. We design comprehensive refractory systems to help customers optimize their equipment life and minimize down time. We are focused on developing and applying time saving practices for refractory installation.



WHAT ALLIED HAS THAT OTHERS DON'T

Allied outshines competitors by going above and beyond to provide customers the best experience, resources and relationship possible.

QUALITY CONTROL

We've focused on quality since inception and strive to supply products that perform consistently.

- Global quality management team
- Strict raw materials qualifications
- Batch testing
- ISO certified since 1985

CUSTOM DESIGN ENGINEERING

Our skilled engineering team employs a variety of programs and calculations to create a custom refractory system for each customer. Our engineered solutions are based on equipment design, thermal considerations and material characteristics.

- Patented technologies
- Optimized product zoning
- Proven safety lining system designs
- Unique installation techniques
- Finite Element Analysis (FEA)
- 3-D modeling
- 7 CAD operators located worldwide

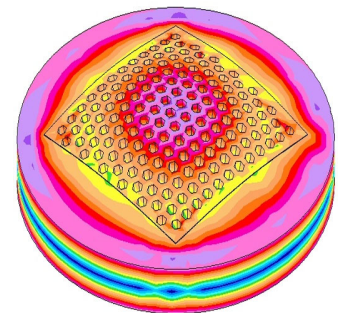
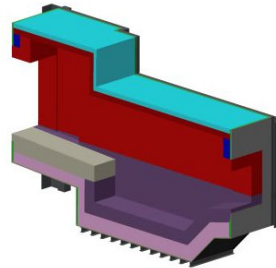
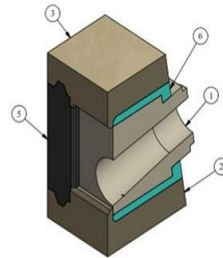

SUPPORTING PRODUCTS

In addition to our extensive refractory products list, we offer a range of ancillary items to support your processes.

- Installation Equipment (mixers, pumps and vibration systems)
- Firebrick & Insulating Firebrick
- Furnace forms
- Ceramic Fiber Insulation
- Slip Plane & Mica
- Fluxes
- Stopper Rods & Nozzles
- Insulating Board & Blocks
- Stainless & Ceramic Anchors
- Cast metal Loops
- Coreless Gas Purging
- Thermocouples & Wire

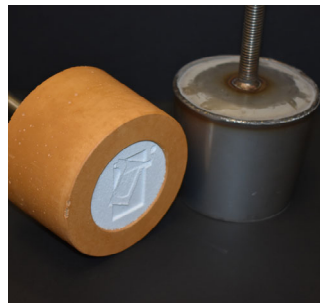

WE ARE AN INNOVATIVE, TECHNOLOGY-DRIVEN SUPPLIER

Allied is focused on developing new products, improving existing products, perfecting installation techniques and creating the ideal refractory system. Our products undergo extensive testing in our state of the art research and technology centers, while our engineers work diligently to understand and meet each customer's unique needs.

RESEARCH AND DEVELOPMENT

We have extensive research capabilities that allow us to develop application-specific products and continuously make improvements. Allied's product development team is comprised of material science experts. Our research department features:

- Patent-generating research
- Shotcreting and gunning laboratory
- Modern analytical testing equipment (XRF, XRD, SEM)
- Forensic analysis capabilities
- Post mortem analysis
- Metal slag evaluations
- Flow testing
- Contact tests

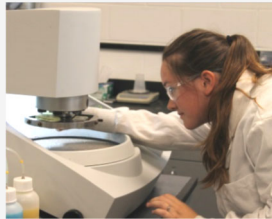

MATERIAL TECHNOLOGY

Allied supplies a large catalog of high performance refractory products for processing nonferrous and ferrous metals and industrial materials.

- Superior raw material quality
- Unique, tailored installation properties: vibration cast, pump cast, gunning and shotcrete
- Product mixes to meet a variety of application demands such as high temperatures, thermal cycling, abrasion and chemical attack

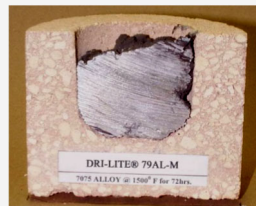

ENGINEERING

Allied's team evaluates operating criteria and physical design parameters to provide detailed reports and recommend the optimal refractory products and/or system. Our engineering department features:

- Optimized product zoning
- Thermal Analysis
- Thermal models to optimize and validate designs
- Proven safety lining system designs
- Innovative refractory system designs
- Detailed 3D model creation
- Comprehensive system drawings

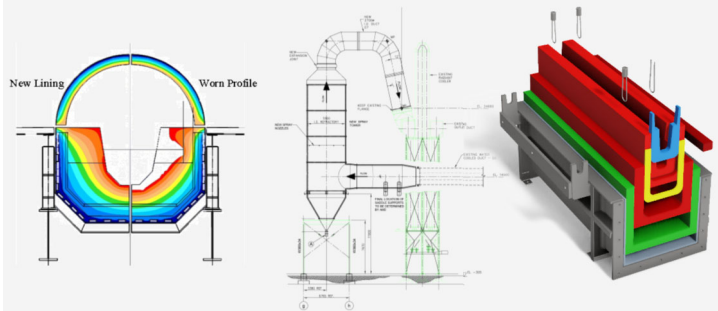

ALLIED MINERAL TECHNICAL SERVICES

Value added technical support for refractory systems

- Melt zone monitoring and modeling
- Data collection and analysis
- Engineering and design services
- Analysis of melt practices
- Emergency responsiveness
- On-site supervision and assistance

Markets served

- Blast Furnaces
- Coke Ovens
- Cupolas



FOUNDRY

Allied's refractory materials for foundries have been used in melting and holding furnaces and transfer vessels for almost 60 years. We are widely recognized for our product reliability in the foundry industry.

TOP PRODUCT LINES

- MINRO-SIL®
- V-CAST®
- DRI-VIBE®
- DRI-VIBE® LGS
- DRI-ROK®
- DRI-LITE®
- DURAGUN®
- METAL KAST
- LCF
- MINRO-AL®

APPLICATIONS

- Coreless Induction Furnace
- Vacuum Induction Furnace
- Channel Induction Furnace
- Pressure Pour Furnace
- Copper Shaft Furnace
- Cupola
- Ladles
- Flooring

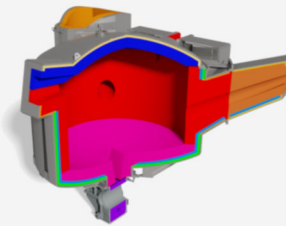
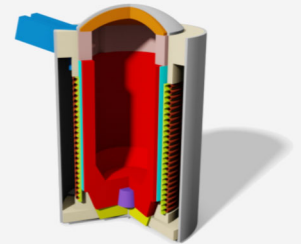

ALUMINUM

We are a world leader in aluminum refractory technology. Our signature product lines cater to specific customer needs—non-wetting, bonding, rapid dry-out, etc. and are designed to handle the various conditions of aluminum melting, holding and transfer applications.

TOP PRODUCT LINES

- QUICK-FIRE®
- QUICK-STICK®
- ARMORMAX®
- MATRICAST
- MATRIFLO
- MATRIPUMP
- QUICK CAST®
- MATRIFIRE
- MATRIPHOS
- TUFFLOOR®
- MATRILITE

APPLICATIONS

- Reverberatory Furnace
- Rotary Furnace
- Induction Furnace
- Die Casting Holder
- Stackmelter
- Carbon Bake Furnace
- Heated Launder
- Unheated Launder
- Ladles
- Flooring

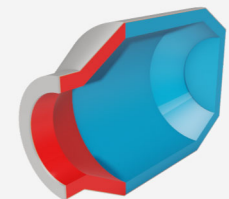
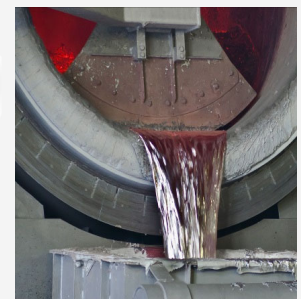
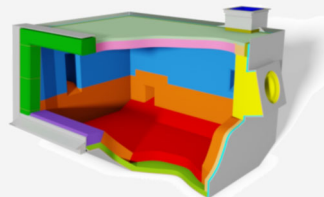

INDUSTRIAL

The industrial market encompasses many diverse fields with unique equipment and needs. Allied carries an extensive line of high-strength monolithic refractories and precast shapes able to withstand repetitive abrasion and wear—ideal solutions for power generation and mineral processing applications.

TOP PRODUCT LINES

- TUFFCRETE®
- ARMORMAX®
- DURACON®
- GUNCAST®
- INSULMIX®
- TUFF-FLO
- DURAGUN®
- GUNCAST®

MARKETS SERVED

- Mineral Processing: cement, lime, ore
- Power
- Boilers
- Waste to Energy
- Incineration
- Glass
- Hearth Products

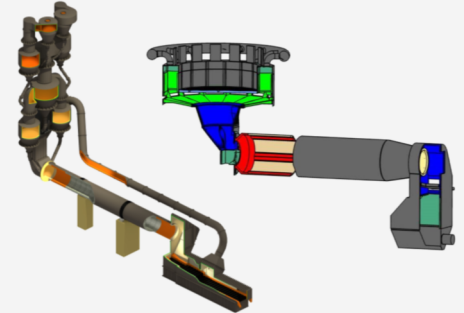

STEEL

The Allied team focuses on maintaining day to day production and resolving refractory issues through cost effective, technology based solutions. We're equipped to meet integrated mill, mini-mill and micro-mill needs with specialized product lines and a commitment to safe and efficient material handling.

TOP PRODUCT LINES

- STACKCRETE®
- V-CAST®
- HC
- LADLE-LITE®
- RAPID PUMP
- LADLE-VIBE®
- DRI-VIBE®

APPLICATIONS

- Blast Furnace
- Casthouse
- Electric Arc Furnace
- Cupola
- Hot Blast Stove
- Spray Tower
- Coke Oven
- Cooling Tower
- Tundishes
- Ladles
- Flooring
- Maintenance Materials



PRECAST REFRACTORY SHAPES

Allied Mineral Products is a leading producer of precast refractory shapes with four wholly owned shapes manufacturing facilities. We provide high quality precast, prefired refractories for virtually any application.

PRECAST SHAPE BENEFITS

- Consistent, Controlled manufacturing Process
- Fast Installation
- Minimized Heat-up Time
- Easier Slag/Dross Removal Due to Lower Porosity
- Extensive product offerings including the ultimate ceramic-metal composite for shapes, METAL-ROK®
- Shapes manufactured from Allied's flagship product lines
- Shape capabilities from 2 lb to 10 tons (1 kg to 9 MT)

MARKETS SERVED

- Foundry
- Aluminum
- Steel
- Cement
- Power
- Mineral Processing
- Home and Hearth
- Forging
- Heat Containment

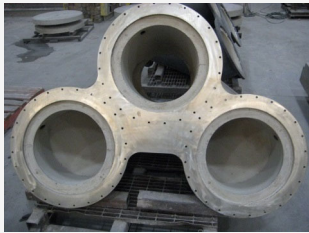

HEAT TREATING AND FORGING

Allied manufactures refractories that are tailored to forging and other thermal processing furnaces. Our products help extend campaign life, improve efficiency and reduce maintenance costs. We specialize in precast shapes for jambs, lintels, sills and pier blocks.

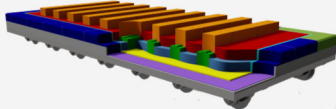
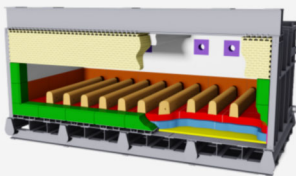

TOP PRODUCT LINES

- ARMORMAX®
- METAL-ROK®
- DRI-VIBE®
- TUFF-FLO
- LCF
- DURACON®

APPLICATIONS

- Car Bottom Furnace
- Box-type Furnace
- Rotary Hearth Furnace
- Walking Beam
- Walking Hearth
- Pusher
- Clamshell
- Induction Billet Heating

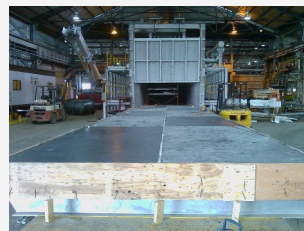

Headquarters:

Allied Mineral Products, LLC

Columbus, Ohio, U.S.A.
614-876-0244 - info@alliedmin.com

USA Manufacturing Locations:

Allied Mineral Products, LLC
Columbus, Ohio, USA
614-876-0244 - info@alliedmin.com

Allied Mineral Products
Chehalis, Washington, USA
614-876-0244 - info@alliedmin.com

Allied Mineral Products
Pell City, Alabama, USA
614-876-0244 - info@alliedmin.com

Allied Mineral Products
Brownsville, Texas, USA
956-831-2022 - info@alliedmin.com

International Manufacturing Locations:

Allied Mineral Products Brazil
Pocos de Caldas, Brazil
614-876-0244 - info@alliedmin.com

Allied Mineral Products Europe B.V.
Tholen, Netherlands
31-166 601200 - customer.service@alliedmin.com

Allied Mineral Products (Foshan) Co., Ltd.
Foshan City, China
86-22-252-10378 - chinasales@alliedmin.com

Allied Mineral Products (Tianjin) Co., Ltd.
Tianjin, China
86-22-252-10378 - chinasales@alliedmin.com

Allied Mineral Products South Africa (Pty) Ltd.
Johannesburg, South Africa
27-11-902-2900 - southafricasales@alliedmin.com

Allied Refractory Products India Private Ltd.
Ahmedabad, Gujarat, India
91-2717-616800 - india@alliedmin.com

Allied Mineral Products Russia
Elabuga, Tatarstan, Russia
79-16-585-2753 - info@alliedmin.com

Licensees:

Refractarios lunge Limitada
Santiago, Chile
56-22-745-3613 - info@alliedmin.com

Nippon Crucible Co., Ltd.
Tokyo, Japan
614-876-0244 - japan@alliedmin.com

Shinagawa Refractories Australasia
Unanderra NSW Australia
+61-2-4222-3834 - info@alliedmin.com

Hagenburger
Grünstadt, Germany
31-16660-5153 - info@alliedmin.com